

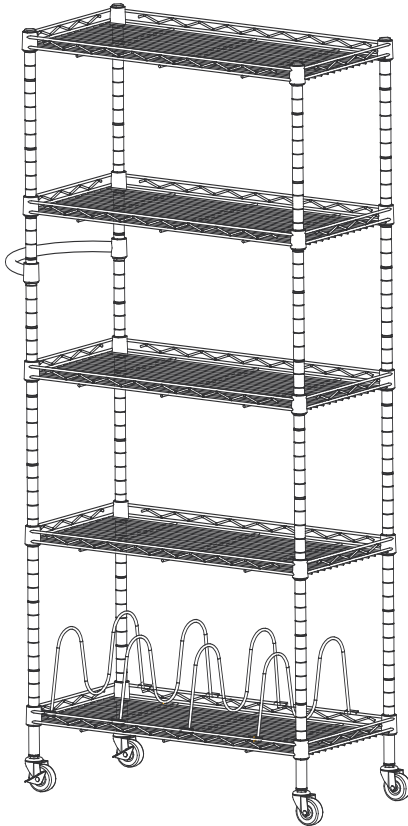

## OWNER'S MANUAL



**TRINITY BASICS 5-TIER NSF 24"x12"x55.5"  
PANTRY RACK  
Model # TBFZ-0955 / TBFPBR-0955**



**Important / Important / Importante**

FOR QUICK & EASY 3D ASSEMBLY INSTRUCTIONS

POUR DES DIRECTIVES D'ASSEMBLAGE 3D RAPIDES ET FACILES

PARA INSTRUCCIONES DE ENSAMBLAJE RÁPIDAS Y SENCILLAS EN 3D

**BILT.**<sup>®</sup>

Intelligent Instructions  
Directives intelligentes  
Instrucciones Inteligentes



# PARTS LIST

Your TRINITY Basics 5-Tier Pantry Rack should include the following parts. Please inspect box contents to ensure you have received all components.

If you are missing any parts, need assistance with assembly or have questions, please contact TRINITY Customer Service: 800.985.5506 or [customerservice@trinityii.com](mailto:customerservice@trinityii.com). Parts can also be requested online via "Contact Us" section at [www.trinityii.com](http://www.trinityii.com).

You will NOT need additional tools for assembly.

A

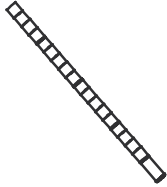

**BOTTOM POLE (4)**  
Threaded Insert (4)  
pre-installed

B

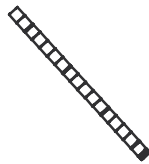

**MIDDLE POLE (4)**  
Pole Connector (4)  
pre-installed

C

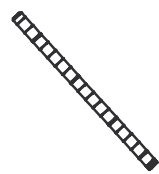

**TOP POLE (4)**  
End Cap (4) and  
Pole Connector (4)  
pre-installed

D



**SHELF (5)**

E



**PUSH HANDLE (1)**

F



**DIVIDER (4)**

G



**SLIP SLEEVE  
(44) + (4) extra**

H



**NON-LOCKING  
CASTER (2)**

I



**LOCKING  
CASTER (2)**

J



**WRENCH (1)**

K

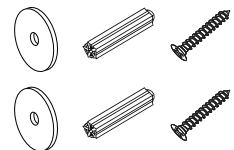

**ANTI-TIP  
HARDWARE PACK  
(1)**



*Note: The black circular plastic spacers in between Shelves are used only for packaging purposes. They are NOT needed. Please discard.*

# ASSEMBLY INSTRUCTIONS

## STEP 1

Screw each CASTER (H) and (I) into each BOTTOM POLE (A). Turn clockwise to screw in place. Make sure locking casters are on same side.

**Use provided caster wrench to tighten completely.**  
**Failure to do as instructed could result in caster stem breaking.**

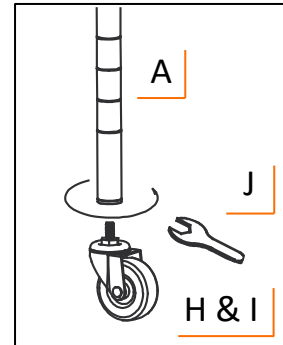
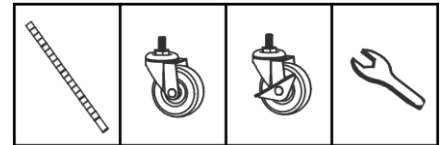

## STEP 2

For easiest assembly, do NOT attach TOP POLES (C), MIDDLE POLES (B) and BOTTOM POLES (A) until instructed. Once connected, these will be posts for the rack.

Note that POLES (A+B+C) have slight horizontal line indentations at 1" intervals. Each SLIP SLEEVE (G) has raised horizontal lines inside designed to lock them in place on POLES (A+B+C).

On BOTTOM POLE (A), place one pair of SLIP SLEEVES (G) at desired height **no higher than** 3rd indentation from bottom. Please make sure arrow faces up and word "TOP" is right side up.

Slide pair of SLIP SLEEVES (G) until you hear a click to confirm pair is locked onto BOTTOM POLE (A). Do this for each BOTTOM POLE (A) and make sure height is identical for each BOTTOM POLE (A). Do NOT place more than one pair on each pole at a time.

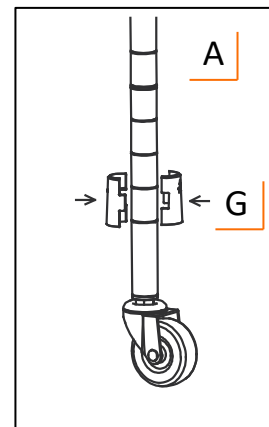
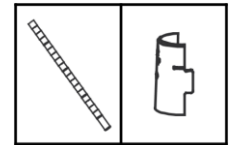

*Note: There will be a very small gap in-between two locked SLIP SLEEVES (G)—this is normal.*

# ASSEMBLY INSTRUCTIONS

## STEP 3

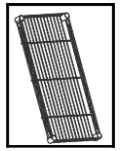

D (1)

Place SHELF (D) on its side and slide each BOTTOM POLE (A) through each corner cylinder on SHELF (D). Make sure SHELF (D) corner cylinders are positioned over SLIP SLEEVES (G).

Stand unit upright.

*Note:*

- Use a rubber mallet, if needed, to secure SHELF (D).
- For convenience, place BOTTOM POLES (A) with Locking Casters on shorter side of shelf.

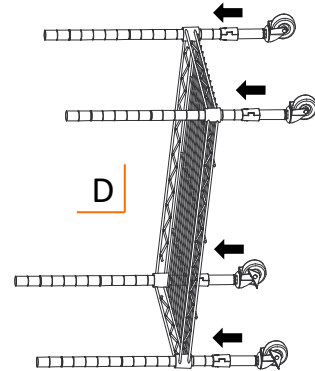

## STEP 4

Screw MIDDLE POLE (B) into BOTTOM POLE (A). Repeat for each remaining MIDDLE POLE (B).

Screw TOP POLE (C) into MIDDLE POLE (B). Repeat for each remaining TOP POLE (C).

*Note:* Top of each TOP POLE (C) is indicated by a BLACK END CAP.

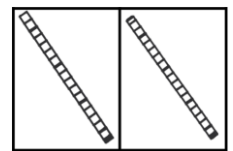

B (4)

C (4)

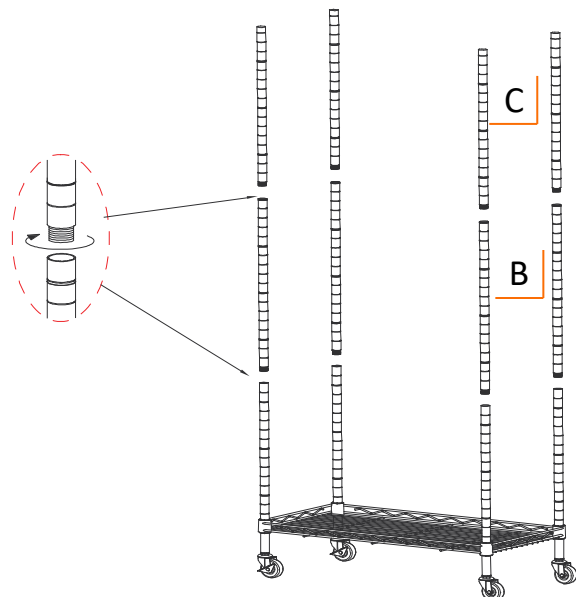

# ASSEMBLY INSTRUCTIONS

## STEP 5

In the same way as indicated in STEP 2 & 3, install 2 SHELVES (D) and then PUSH HANDLE (E).

Then install another 2 SHELVES (D) above PUSH HANDLE (E).

**Note:**

- PUSH HANDLE (E) height needs to be pre-determined and assembled in right order.
- Shelves are adjustable in 1" increments and can be placed as needed to best fit storage needs.
- Use a rubber mallet, if needed, to secure SHELVES (D) and PUSH HANDLE (E).

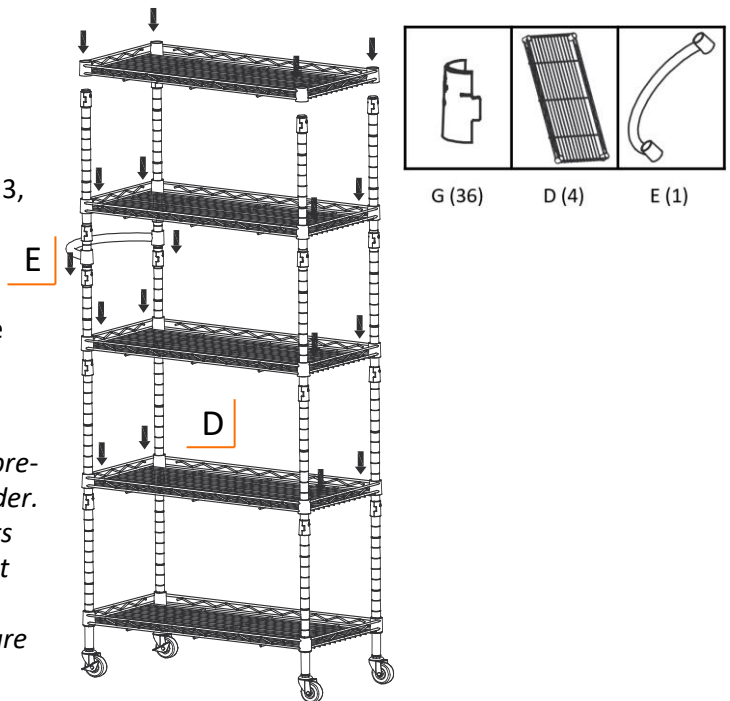

## STEP 6

Clip one end of DIVIDER (F) onto straight wire of SHELF (D) frame as shown, then squeeze other end of DIVIDER (F) to clip onto other side of SHELF (D) frame.

Install other DIVIDERS (F) on SHELVES (D) as desired.

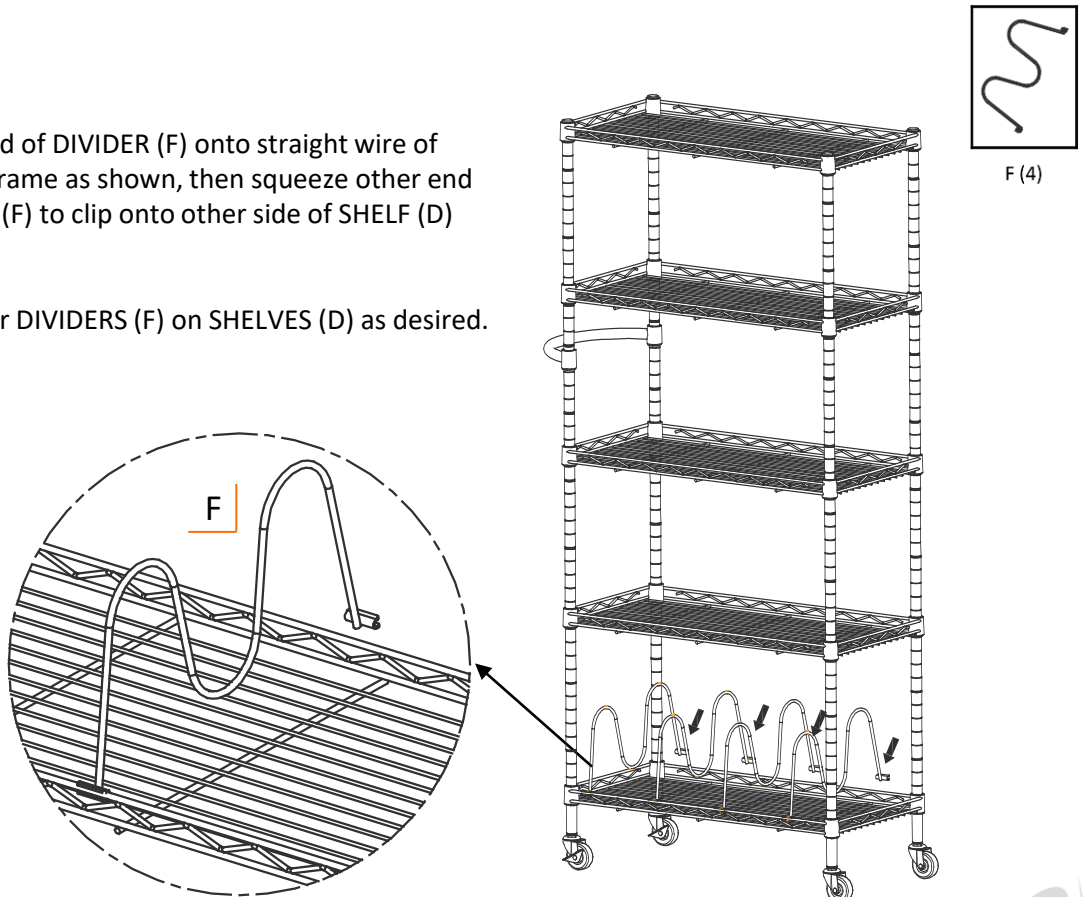

# ASSEMBLY INSTRUCTIONS

## Anti-tip Hardware Installation

**ANTI-TIP HARDWARE PACK (K)** is used to protect against accidental tipping – especially due to curious children. Note that installing ANTI-TIP HARDWARE PACK (K) will no longer allow your rack to be mobile.

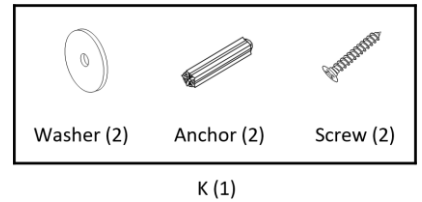

### On Wood Stud

Determine wood stud location and mark it on wall, level with topmost shelf. Do this on two different studs along top shelf.

Place Shelving Rack into position.

Insert Screw through Washer and backside frame of top shelf as shown. Fasten Screw tightly into stud. Do this for each stud that was marked out.

### On Brick/Concrete

Mark out two separate locations on wall, level with topmost shelf.

With a 1/4" drill bit, drill a hole 1-1/4" deep at each marked location. Push Anchors flush into each hole.

Place Shelving Rack into position.

Insert Screw through Washer and backside frame of top shelf as shown. Fasten Screw tightly into Anchor. Do this on both Anchors that were placed in wall.

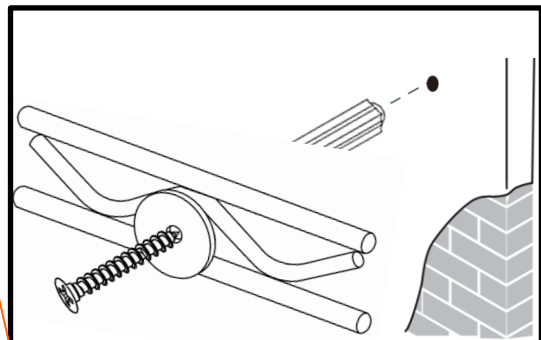
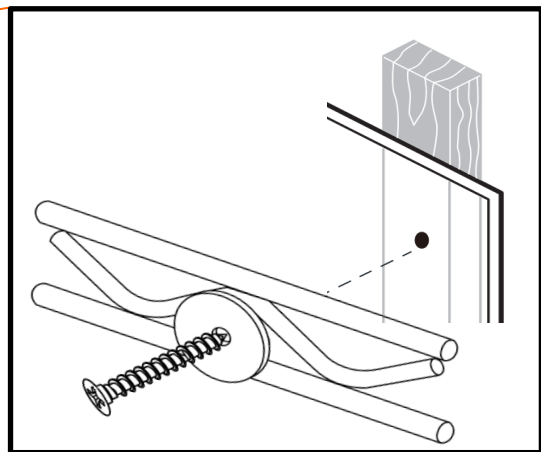
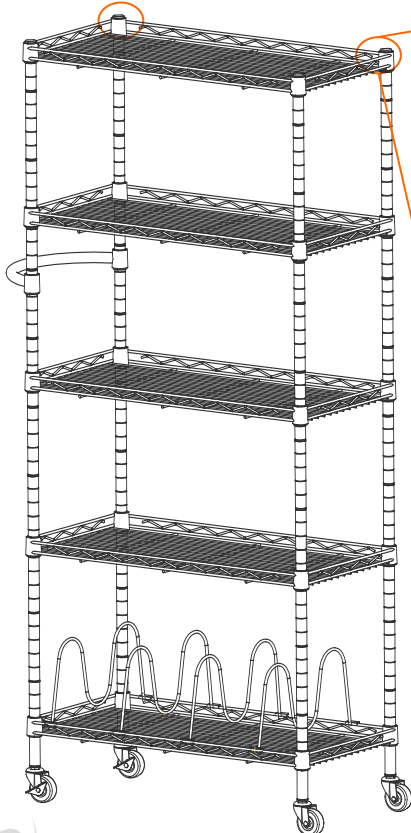

## SERVICE PARTS LIST – TBFZ-0955 Chrome Color

TRINITY Customer Service provides the following replacement parts:

#	Part Number	Description	#	Part Number	Description
1)	ZSV-03-079-2412	Shelf	8)	XXX-97-002-0005	Wrench
2)	ZSV-04-047-1650	Top Pole	9)	ZSV-02-012-0003	Divider
3)	ZSV-01-029-1922	Pole Connector	10)	XBK-01-011-1936	Slip Sleeve
4)	ZSV-04-048-1800	Middle Pole	11)	ZSV-05-028-1200	Handle
5)	ZSV-04-049-1825	Bottom Pole	12)	ZSV-02-011-0001	Anti-tip Hardware Pack
6)	ZSV-99-007-2008	Non-locking Caster	13)	XBK-23-004-1911	End Cap
7)	ZSV-99-008-2008	Locking Caster			

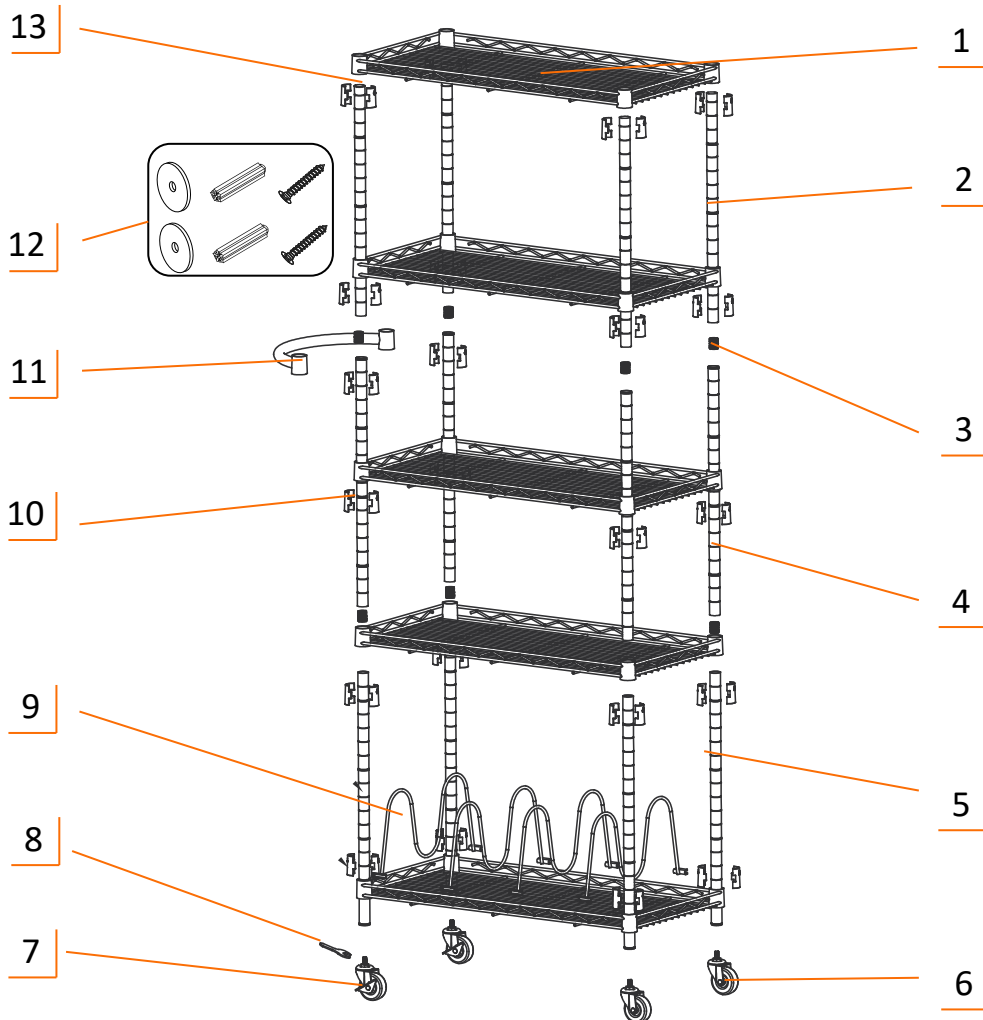

## SERVICE PARTS LIST – TBFPBR-0955 Bronze Color

TRINITY Customer Service provides the following replacement parts:

#	Part Number	Description	#	Part Number	Description
1)	PBR-03-079-2412	Shelf	8)	XXX-97-002-0005	Wrench
2)	PBR-04-047-1650	Top Pole	9)	PBR-02-012-0003	Divider
3)	ZSV-01-029-1922	Pole Connector	10)	XBK-01-011-1936	Slip Sleeve
4)	PBR-04-048-1800	Middle Pole	11)	PBR-05-028-1200	Handle
5)	PBR-04-049-1825	Bottom Pole	12)	ZSV-02-011-0001	Anti-tip Hardware Pack
6)	ZSV-99-007-2008	Non-locking Caster	13)	XBK-23-004-1911	End Cap
7)	ZSV-99-008-2008	Locking Caster			

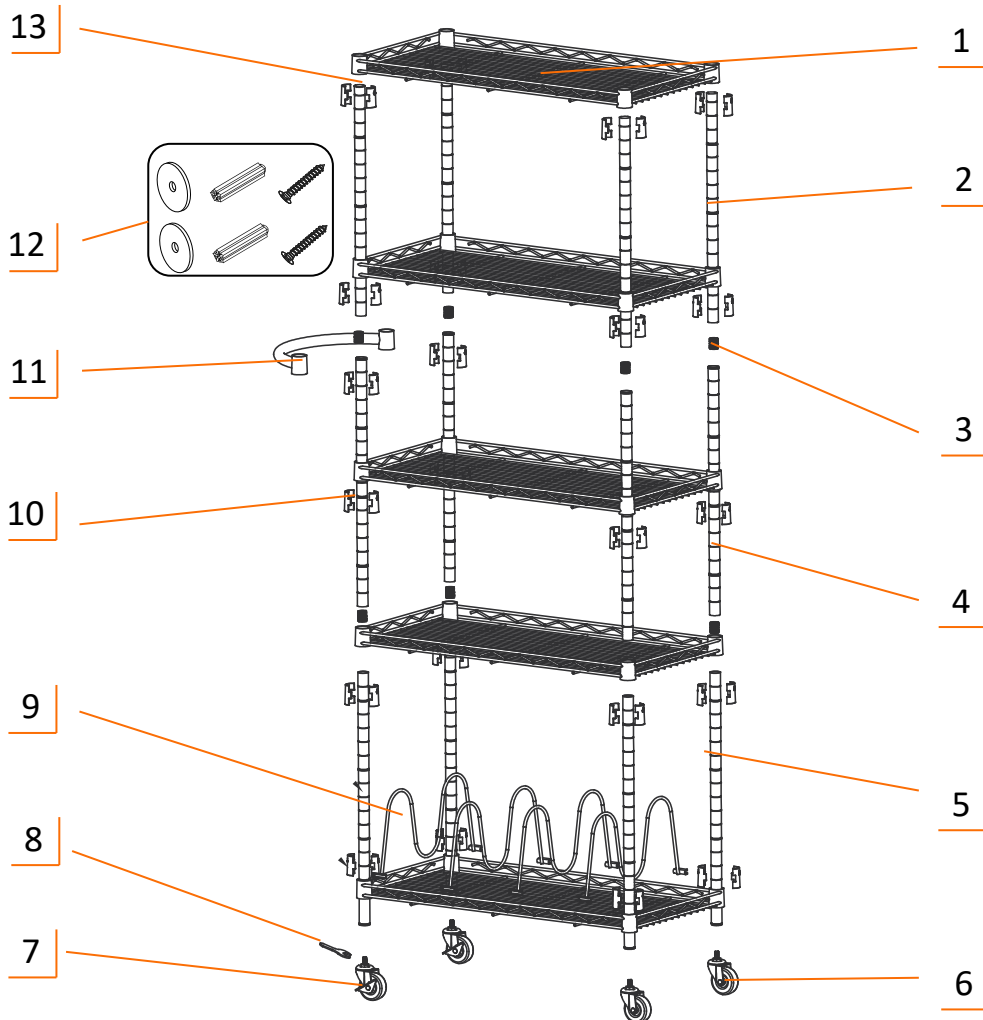



---

## WARNINGS

1. **Read and understand all instructions.** Failure to follow all instructions may result in injury and/or damage.
2. **Use the provided caster wrench to tighten casters completely.** Failure to do as instructed could result in the caster stem breaking thereby causing the shelving rack to collapse.
3. **The warnings, cautions, and instructions discussed in this manual cannot cover all possible conditions or situations that may occur.** The user must always be aware of the environment where the product will be placed and make sure to use the product in a safe and responsible manner.
4. **Do NOT modify the product in any way.** Unauthorized modification may impair the function and/or safety of the product, and may affect the life of the product. Any modifications will void product warranty.
5. **Check for damaged parts.** Before using this product, carefully check that all parts are in good condition, and that the product will operate properly and perform its intended function. Check for damaged parts and any other conditions that may affect the operation of this product. Replace damaged or worn parts, and never use this product with a damaged part.
6. **Do NOT overload the product.**

Weight capacity per shelf (evenly distributed)	<b>50 lb</b>
Total weight capacity of shelving rack (evenly distributed)	<b>250 lb</b>

7. **Do NOT allow children to climb or play around the product.** Tipping may occur causing injury.
8. **Do NOT roll the product on an uneven surface.** Only move the product on a smooth surface. Rolling over rough or uneven surfaces may cause casters to break or items on the product to fall, resulting in injury and / or damage. Wood and laminate flooring can be scratched or dented. Ensure your flooring can bear the weight of the rack before rolling the rack across your flooring.
9. **Load the product evenly and place the heaviest items on the lower shelves.**
10. **Always lock the locking casters when not moving the product.**

---

## CARE AND MAINTENANCE

- Avoid harsh, abrasive cleaners, and other corrosive chemicals.
- This product is not certified for outdoor use.

# PRODUCT REGISTRATION

Thank you for purchasing a TRINITY Basics 5-Tier Pantry Rack. In order to register your product and receive streamlined customer service, please fill out the following Product Registration Form and (1) fax the form to 310.347.4134 (2) complete the Product Registration Form online at [www.trinityii.com](http://www.trinityii.com) or (3) scan and email the form to [customerservice@trinityii.com](mailto:customerservice@trinityii.com). Include a copy of your original receipt with your submission.

First Name: \_\_\_\_\_ Last Name: \_\_\_\_\_

Address: \_\_\_\_\_

City: \_\_\_\_\_ State: \_\_\_\_\_ Zip Code: \_\_\_\_\_

Email Address: \_\_\_\_\_ Phone: \_\_\_\_\_

Product Model #: \_\_\_\_\_ Purchase Date: \_\_\_\_ / \_\_\_\_ / \_\_\_\_

Location of Purchase: \_\_\_\_\_

Please rate the importance of each feature (1=least important; 10=most important)

Quality \_\_\_\_ Price \_\_\_\_ Size/Capacity \_\_\_\_ Appearance \_\_\_\_ Other \_\_\_\_

How did you hear about our product?

- Magazine Ad     Catalog     Salesperson     Word of Mouth  
 Internet     Store Display     Other

Marital Status:                       Single                       Married

Household Income:                 Below \$50,000     \$50,000-\$150,000     \$150,000+

Education:                           High School             College             Graduate School

Primary Residence:                 Own                       Rent

Comments/Suggestions:



# 1 YEAR LIMITED WARRANTY

## **TRINITY Basics 5-Tier Pantry Rack Model # TBFZ-0955 / TBFBR-0955**

Trinity International Industries (“Trinity”) warrants to the original consumer purchaser (“Purchaser”) of the TRINITY Basics 5-Tier Pantry Rack (“Product”) that each Product shall be free from defects in workmanship and materials for a period of 1 year from the date of original purchase. Trinity’s obligation under this warranty shall be limited to repair or replacement of, or adequate compensation for the Product which shall not be greater than the amount of the purchase price of the Product, at the option of Trinity, during the warranty period. All replaced parts and Products become the property of Trinity and must be returned to Trinity.

This warranty excludes normal wear and tear of the Product and its parts or components, and damage arising from any of the following: negligent use or misuse of the Product, use contrary to this User’s Manual, or alteration by any one other than Trinity. The warranty period of 1 year shall not be extended or renewed by the repair or replacement of, or compensation for, the Product. Any warranty implied by applicable law is limited in duration to one year from the date of purchase and is subject to the same conditions and limitations as is provided for our express warranty.

Except as set forth herein, and to the extent of applicable there are no warranties on this Product either express or implied, and Trinity disclaims all warranties including, but not limited to, any implied warranties of merchantability, infringement or fitness for a particular purpose. No warranty or guarantee given by any person, firm, or corporation with respect to this product shall be binding on Trinity.

If your Product is defective or otherwise requires service or parts, please call TRINITY Customer Service toll-free at (800) 985-5506, between 5:00 a.m. and 5:00 p.m., PST. Please tell us which model you purchased, the date of the purchase, and the problem with your Product. A copy of your original purchase receipt must accompany your service request.

## **LIMITATION OF REMEDIES AND LIABILITY**

Trinity (and its employees, officers, members, managers, affiliates and assigns) shall not be liable for any incidental, consequential, special, indirect, remote, special or punitive damages for breach of any warranty, express or implied, including, but not limited to, lost profits, lost savings, loss of anticipated benefits and attorneys’ fees, which arise out of the purchase, use or inability to use the Product, whether arising out of contract, negligence, strict tort, product liability, or any other legal theory on which a claim is based. As noted above, to the extent damages are allowed by our express warranty or by applicable law, those damages may not exceed the purchase price paid for the Product. Without limiting the foregoing Purchaser assumes all risk and liability for loss, damage or injury to Purchaser and Purchaser’s property and to others and their property arising out of the use, misuse, or inability to use this Product. This limited warranty shall not extend to anyone other than the original purchaser of this product, is nontransferable and states your exclusive remedy.

Some states do not allow the exclusion or limitation of incidental, consequential, special, or punitive damages, so the above limitation or exclusion may not apply to you. The above warranty gives you specific legal rights, and you may have other rights which vary from state to state.

---

## CONTACT US

**QUESTIONS? NEED PARTS?  
WE ARE HERE TO HELP!**

**Please feel free to contact us. There are no questions too small, or any problems too big. We're committed to providing our customers with the highest level of service.**

### **TRINITY Customer Service**

**TEL: 800.985.5506**

**FAX: 310.347.4134**

**EMAIL: [customerservice@trinityii.com](mailto:customerservice@trinityii.com)**

**Monday through Friday  
5:00 AM – 5:00 PM (PST)**

**[www.trinityii.com](http://www.trinityii.com)**