

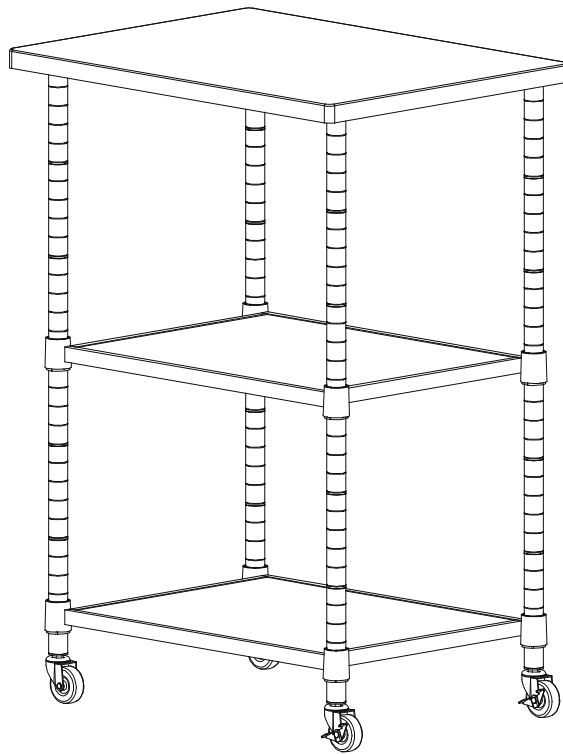

OWNER'S MANUAL



TRINITY BASICS BAMBOO TOP KITCHEN CART W/ SOLID SHELF Model # TBFPR-1417

Important / Important / Importante

FOR 3D ASSEMBLY INSTRUCTIONS
POUR DES DIRECTIVES D'ASSEMBLAGE 3D
PARA INSTRUCCIONES DE ENSAMBLAJE EN 3D



BILT.[®]

Intelligent Instructions
Directives intelligentes
Instrucciones Inteligentes



PARTS LIST

Your TRINITY BASICS Bamboo Top Kitchen Cart w/ Solid Shelf should include the following parts. Please inspect box contents to ensure you have received all components.

If you are missing any parts, need assistance with assembly or have questions, please contact TRINITY Customer Service: 800.985.5506 or customerservice@trinityii.com. Parts can also be requested online via our "Contact Us" section at www.trinityii.com.

A

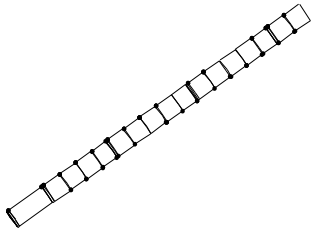

BOTTOM POLE (4)

B

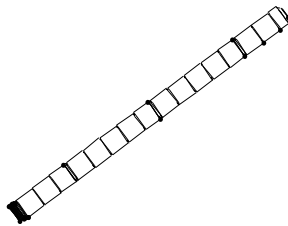

TOP POLE (4)
End Cap (4) and
Pole Connector (4)
pre-installed

C



SLIP SLEEVE
(16) + (2) extra

D

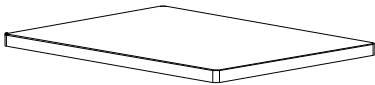

**BAMBOO CUTTING
BOARD (1)**

E

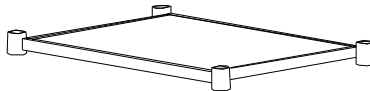

SHELF (2)

F



LOCKING CASTER
(2)

G

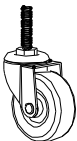

**NON-LOCKING
CASTER (2)**

H



WRENCH (1)

ASSEMBLY INSTRUCTIONS

STEP 1

Screw each CASTER (F & G) into bottom of each BOTTOM POLE (A). Turn clockwise to screw in place. Make sure LOCKING CASTERS (F) are on same side of Kitchen Cart.

Warning: Use provided caster wrench to tighten completely. Failure to do as instructed could result in caster stem breaking.

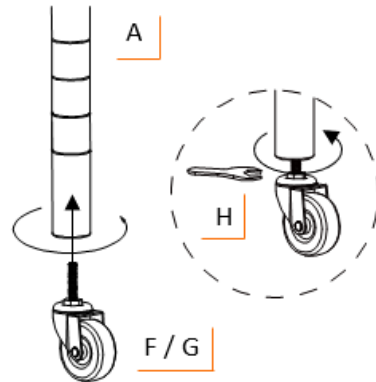
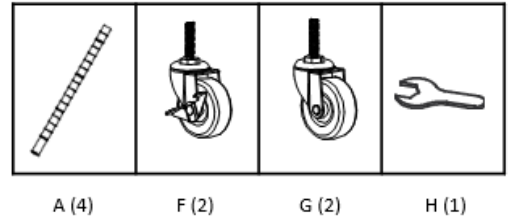

STEP 2

On each BOTTOM POLE (A), place one pair of SLIP SLEEVES (C) at desired height **no higher than 3rd** indentation from bottom. Make sure arrow faces up and word “TOP” is right-side up. Make sure SLIP SLEEVES (C) height is identical for each BOTTOM POLE (A).

Note that each POLE (A+B) has slight horizontal line indentations at 1” intervals. Each SLIP SLEEVE (C) has raised horizontal lines inside designed to lock in place on POLES (A+B).

Slide pair of SLIP SLEEVES (C) until you hear a click to confirm the pair is locked onto BOTTOM POLE (A). Do NOT place more than one pair on each POLE (A+B) at a time.

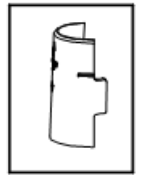

C (8)

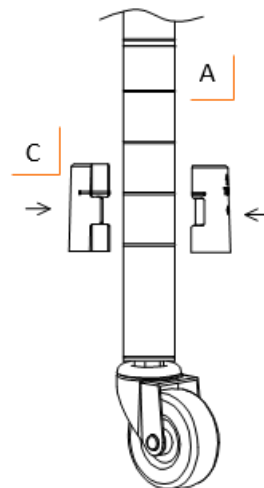

Note: There will be a very small gap in-between two locked SLIP SLEEVES (C)—this is normal.

ASSEMBLY INSTRUCTIONS

STEP 3

Place SHELF (E) on its side and slide each BOTTOM POLE (A) through each corner cylinder of SHELF (E). Make sure corner cylinders are positioned over SLIP SLEEVES (C).

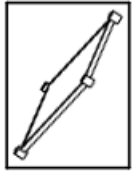

E (1)

Slowly stand unit upright.

Note:

Use a rubber mallet, if needed, to secure SHELF (E).

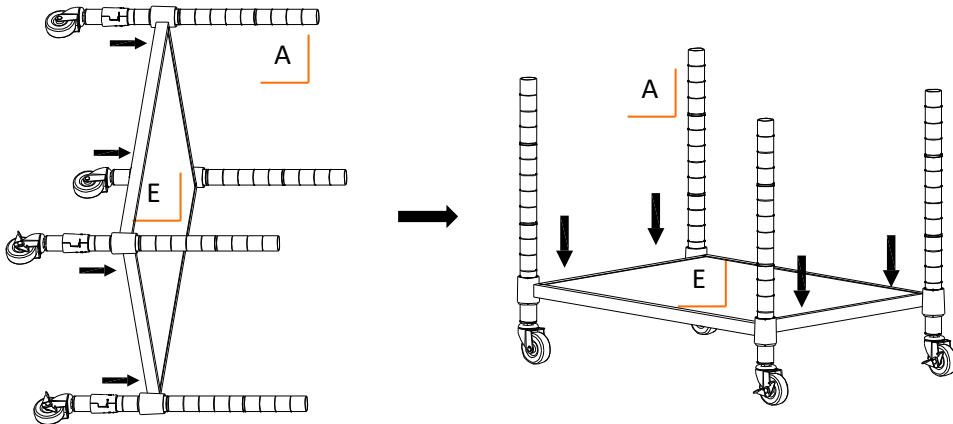

STEP 4

Screw TOP POLES (B) into BOTTOM POLES (A) in clockwise direction.

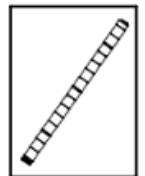

B (4)

Note:

The top of each TOP POLE (B) is indicated by a BLACK END CAP.

Pole Connectors are pre-installed in bottom of TOP POLES (B).

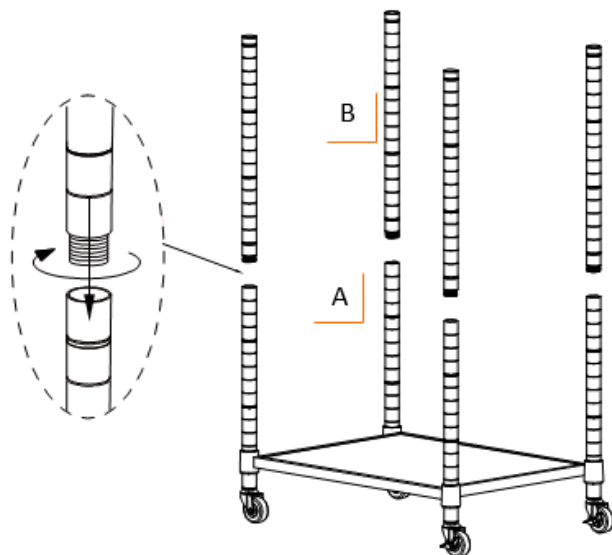

ASSEMBLY INSTRUCTIONS

STEP 5

Repeat STEP 2 & 3 to assemble other SHELF (E). Make sure SLIP SLEEVES (C) height is identical.

Place BAMBOO CUTTING BOARD (D) on top of TOP POLES (B). Make sure top of each TOP POLE (B) is inside each corner pocket of BAMBOO CUTTING BOARD (D).

Note:

Use a rubber mallet, if needed, to secure SHELF (E).

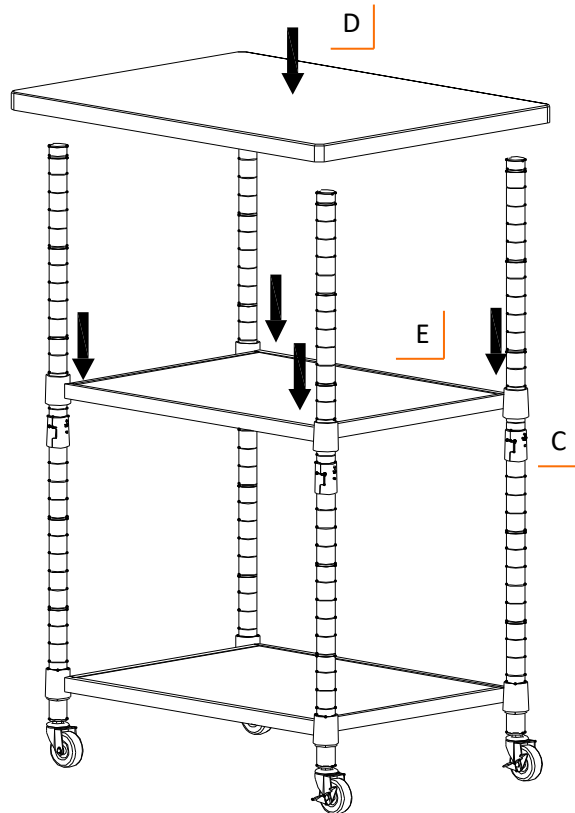
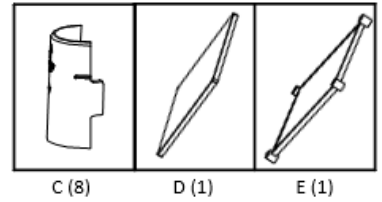

SERVICE PARTS LIST – TBFPR-1417 (Dark Bronze)

TRINITY Customer Service provides the following replacement parts:

Part Number	Description	Part Number	Description
1) ONA-20-004-2418	Bamboo Board	6) ZSV-99-007-2008	Non-locking Caster
2) PBR-04-029-1675	Top Pole	7) XXX-97-002-0001	Wrench
3) XBK-01-012-2543	Slip Sleeve	8) PBR-03-114-2216	Shelf
4) PBR-04-031-1525	Bottom Pole	9) ZSV-01-030-2523	Pole Connector
5) ZSV-99-008-2008	Locking Caster	10) XBK-23-004-2517	End Cap

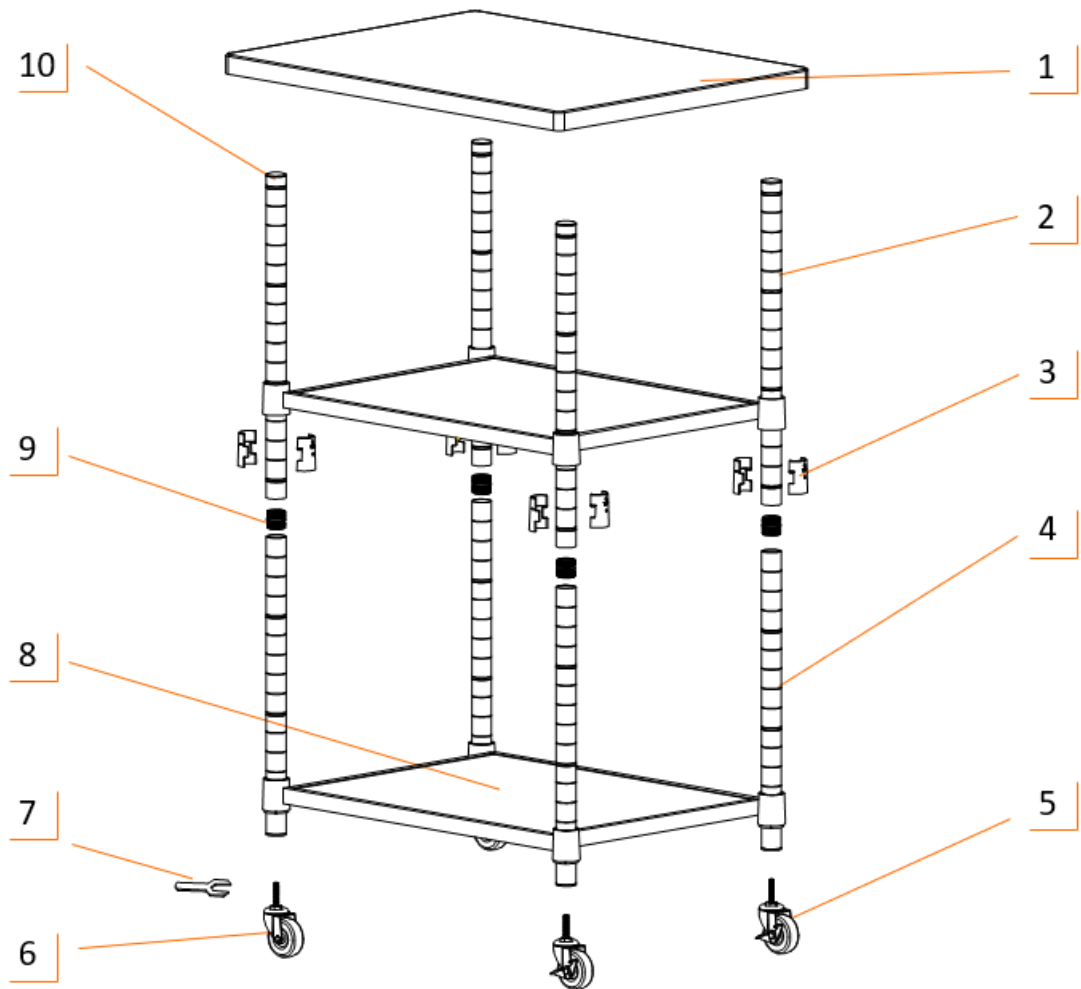

WARNINGS

1. **Read and understand all instructions.** Failure to follow all instructions may result in injury and/or damage.
2. **Use the provided caster wrench to tighten casters completely.** Failure to do as instructed could result in the caster stem breaking thereby causing the cart to collapse.
3. **The warnings, cautions, and instructions discussed in this manual cannot cover all possible conditions or situations that may occur.** The user must always be aware of their environment and ensure that they use the product in a safe and responsible manner.
4. **Do NOT modify the product in any way.** Unauthorized modification may impair the function and/or safety of the product, and may affect the life of the product. Any modifications will void product warranty.
5. **Check for damaged parts.** Before using this product, carefully check that all parts are in good condition, and that the product will operate properly and perform its intended function. Check for damaged parts and any other conditions that may affect the operation of this product. Replace damaged or worn parts, and never use this product with a damaged part.
6. **Do NOT overload the product.**

Weight capacity on Top (evenly distributed)	150 lb
Weight capacity per Shelf (evenly distributed)	75 lb
Total weight capacity of Cart (evenly distributed)	300 lb

7. **Do NOT allow children to climb or play around the product.**
8. **Do NOT roll the product on an uneven surface. Only move the product on a smooth surface.** Rolling over rough or uneven surfaces may cause casters to break or items on the product to fall, resulting in injury and / or damage. Wood and laminate flooring can be scratched or dented. Ensure your flooring can bear the weight of loaded product before rolling loaded product across your flooring.
9. **Regularly check and secure all parts.**
10. **Do not stand on or use any part of this item as a step ladder.**
11. **Make sure that the wheels are LOCKED when using the bamboo board as a cutting or work surface.**

CARE AND MAINTENANCE

- Avoid harsh, abrasive cleaners, and other corrosive chemicals.
- Bamboo board should be hand washed only and periodically treated with food safe oil.



PRODUCT REGISTRATION

Thank you for purchasing a TRINITY BASICS Bamboo Top Kitchen Cart w/ Solid Shelf. In order to register your product and receive streamlined customer service, please fill out the following Product Registration Form and (1) fax the form to 310.347.4134 (2) complete the Product Registration Form online at www.trinityii.com or (3) scan and email the form to customerservice@trinityii.com. Include a copy of your original receipt with your submission.

First Name: _____ Last Name: _____

Address: _____

City: _____ State: _____ Zip Code: _____

Email Address: _____ Phone: _____

Product Model #: TBFPBR-1417 Purchase Date: ____ / ____ / ____

Location of Purchase: _____

Please rate the importance of each feature (1=least important; 10=most important)

Quality ____ Price ____ Size/Capacity ____ Appearance ____ Other ____

How did you hear about our product?

- Magazine Ad Catalog Salesperson Word of Mouth
 Internet Store Display Other

Marital Status: Single Married

Household Income: Below \$50,000 \$50,000-\$150,000 \$150,000+

Education: High School College Graduate School

Primary Residence: Own Rent

Comments/Suggestions:



1 YEAR LIMITED WARRANTY

TRINITY BASICS Bamboo Top Kitchen Cart w/ Solid Shelf Model # TBFBR-1417

Trinity International Industries (“Trinity”) warrants to the original consumer purchaser (“Purchaser”) of the TRINITY BASICS Bamboo Top Kitchen Cart w/ Solid Shelf (“Product”) that each Product shall be free from defects in workmanship and materials for a period of 1 year from the date of original purchase. Trinity’s obligation under this warranty shall be limited to repair or replacement of, or adequate compensation for the Product which shall not be greater than the amount of the purchase price of the Product, at the option of Trinity, during the warranty period. All replaced parts and Products become the property of Trinity and must be returned to Trinity.

This warranty excludes normal wear and tear of the Product and its parts or components, and damage arising from any of the following: negligent use or misuse of the Product, use contrary to this User’s Manual, or alteration by anyone other than Trinity. The warranty period of 1 year shall not be extended or renewed by the repair or replacement of, or compensation for, the Product. Any warranty implied by applicable law is limited in duration to one year from the date of purchase and is subject to the same conditions and limitations as is provided for our express warranty.

Except as set forth herein, and to the extent of applicable there are no warranties on this Product either express or implied, and Trinity disclaims all warranties including, but not limited to, any implied warranties of merchantability, infringement or fitness for a particular purpose. No warranty or guarantee given by any person, firm, or corporation with respect to this product shall be binding on Trinity.

If your Product is defective or otherwise requires service or parts, please call TRINITY Customer Service toll-free at (800) 985-5506, between 5:00 a.m. and 5:00 p.m., PST. Please tell us which model you purchased, the date of the purchase, and the problem with your Product. A copy of your original purchase receipt must accompany your service request.

LIMITATION OF REMEDIES AND LIABILITY

Trinity (and its employees, officers, members, managers, affiliates and assigns) shall not be liable for any incidental, consequential, special, indirect, remote, special or punitive damages for breach of any warranty, express or implied, including, but not limited to, lost profits, lost savings, loss of anticipated benefits and attorneys’ fees, which arise out of the purchase, use or inability to use the Product, whether arising out of contract, negligence, strict tort, product liability, or any other legal theory on which a claim is based. As noted above, to the extent damages are allowed by our express warranty or by applicable law, those damages may not exceed the purchase price paid for the Product. Without limiting the foregoing Purchaser assumes all risk and liability for loss, damage or injury to Purchaser and Purchaser’s property and to others and their property arising out of the use, misuse, or inability to use this Product. This limited warranty shall not extend to anyone other than the original purchaser of this product, is nontransferable and states your exclusive remedy.

Some states do not allow the exclusion or limitation of incidental, consequential, special, or punitive damages, so the above limitation or exclusion may not apply to you. The above warranty gives you specific legal rights, and you may have other rights which vary from state to state.

CONTACT US

**QUESTIONS? NEED PARTS?
WE ARE HERE TO HELP!**

Please feel free to contact us. There are no questions too small, or any problems too big. We're committed to providing our customers with the highest level of service.

TRINITY Customer Service

TEL: 800.985.5506

FAX: 310.347.4134

EMAIL: customerservice@trinityii.com

**Monday through Friday
5:00 AM – 5:00 PM (PST)**

www.trinityii.com